

Article number: 2082267M12B

Description: E+G Mini indexing plunger
with/without rest position, GN 822.6-7-M12-B

Measures

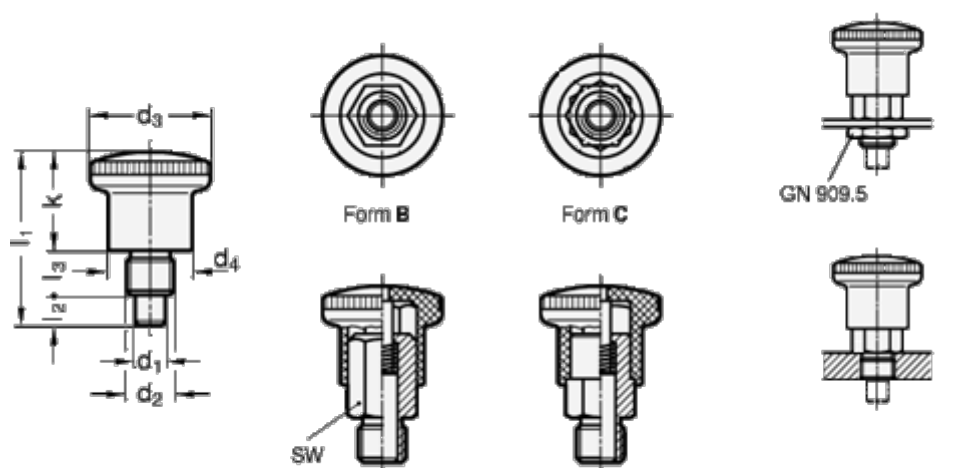

$d_1 = 7$

$d_2 = M12$

$d_3 = 28$

$d_4 = 20$

$k = 23.5$

$l_1 = 40.5$

$l_2 = 7$

$l_3 = 10$

Spring load initial $N = 10$